



SENNHEISER



Flex 5000

Digital wireless audio system for headphones

Instruction manual

Contents

Important safety instructions	3
Package contents	6
Product overview	7
Putting the Flex 5000 into operation	10
Setting up the transmitter	10
Connecting the transmitter to an audio source	11
Connecting the transmitter to the power supply system	15
Charging the receiver's rechargeable battery	16
Displaying the remaining operating time of the rechargeable battery	17
Using the charging reminder function	17
Using the Flex 5000	18
Connecting headphones or an induction loop to the receiver	18
Switching the wireless headphone system on	19
Switching the wireless headphone system off	20
Attaching the receiver to clothing	20
Adjusting the volume	21
Adjusting the balance	22
Selecting a hearing profile for sound enhancement	23
Activating/deactivating the speech intelligibility function	25
Cleaning and maintaining the Flex 5000	26
Replacing the receiver's rechargeable battery	26
Using additional functions	27
Pairing one or several receivers with the transmitter	27
Advanced settings	28
Restoring the factory default settings	31
Charging the rechargeable battery using the MCA 800 charging adapter	32
If a problem occurs	33
Leaving the range of the transmitter	35
Specifications	36
Manufacturer Declarations	38

Important safety instructions



- ▶ Read this instruction manual carefully and completely before using the product.
- ▶ Always include this instruction manual when passing the product on to third parties.
- ▶ Do not use an obviously defective product.
- ▶ Only use the product in environments where wireless 2.4 GHz transmission is permitted.

Preventing damage to health and accidents



- ▶ These headphones allow you to set higher volumes than conventional headphones. Protect your hearing from high volume levels.
Permanent hearing damage may occur when headphones are used at high volume levels for long periods of time. Sennheiser headphones sound exceptionally good and provide clear speech intelligibility at low and medium volume levels.
- ▶ To prevent hearing damage, set the volume to a low level before passing the product on to third parties.
- ▶ Do not use the product in an environment that requires your special attention (e.g. in traffic or when performing skilled jobs).
- ▶ Always keep the headphones/MCA 800 charging adapter at least 3.94" (10 cm) from cardiac pacemakers or implanted defibrillators. The headphones/MCA 800 charging adapter contain/s magnets that generate a magnetic field which could cause interference with cardiac pacemakers and implanted defibrillators.
- ▶ Do not use the product near water. To reduce the risk of fire or electric shock, do not expose the product to rain or moisture.
- ▶ Keep the product, accessories and packaging parts out of reach of children and pets to prevent accidents and choking hazards.
- ▶ Only use the power supply units supplied by Sennheiser.

Preventing damage to the product and malfunctions

- ▶ Always keep the product dry and do not expose it to extreme temperatures to avoid corrosion or deformation. The normal operating temperature is from 5 to 40 °C/41 to 104 °F.
- ▶ Use the product with care and store it in a clean, dust-free environment.
- ▶ Switch off the product after use to conserve battery power.
- ▶ Unplug the power supply unit from the wall socket
 - to completely disconnect the product from the power source,
 - during lightning storms or
 - when not using the product for long periods of time.

- ▶ Always ensure that the power supply unit is
 - in a safe operating condition and easily accessible,
 - properly plugged into the wall socket,
 - only operated within the permissible temperature range,
 - not exposed to direct sunlight for longer periods of time in order to prevent heat accumulation.
- ▶ Varnish or furniture polish may degrade the feet of the transmitter, which could stain your furniture. You should therefore place the transmitter on a non-slip pad to avoid potential staining of furniture.
- ▶ Do not operate the product near heat sources.
- ▶ Clean the product only with a soft, dry cloth.
- ▶ Use only attachments/accessories/spare parts supplied or recommended by Sennheiser.

Safety instructions for lithium polymer rechargeable batteries



WARNING

If abused or misused, the standard/rechargeable batteries may leak. In extreme cases, they may even present a risk of

- explosion,
- fire development,
- heat generation,
- smoke or gas development.

	Switch rechargeable battery-powered products off after use.
	Do not charge a product with a built-in rechargeable battery if the product is obviously defective.
	Only use rechargeable batteries and chargers recommended by Sennheiser.
	Only charge rechargeable batteries at ambient temperatures between 5 to 40 °C/41 to 104 °F.
	When not using rechargeable batteries for extended periods of time, charge them regularly (about every three months).
	Do not heat above 70 °C/158 °F, e.g. do not expose to sunlight or throw into a fire.
	Dispose of batteries/rechargeable batteries at special collection points or return them to your specialist dealer.

Intended use/Liability

This wireless TV headphone system is suitable for use with TV sets, hi-fi systems, and home cinema systems and can be connected to analog and digital audio sources.

This product is intended for private domestic use only. It is not suitable for commercial use. This product is also not intended to be used with portable audio devices.

It is considered improper use when the product is used for any application not named in the corresponding product documentation.

Sennheiser does not accept liability for damage arising from abuse or misuse of this product and its attachments/accessories.

Before putting into operation, please observe the respective country-specific regulations.

Package contents



RR Flex receiver with built-in rechargeable battery



TR 5000 transmitter with charging station



MX 475 earphones

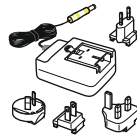

NT 5-10AW power supply unit with multi-country adapters (EU, UK, US, AU)



Optical digital cable, 1.5 m



Stereo audio cable with 3.5 mm jack plugs, 1.5 m

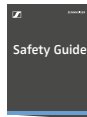

Safety guide



Quick guide



Instruction manual in English, German, French, and Spanish

The instruction manual in other languages can be downloaded as a PDF file at www.sennheiser.com/download.



A list of accessories can be found on the Flex 5000 product page at www.sennheiser.com. For information on suppliers, contact your Sennheiser partner. To find a Sennheiser partner in your country, search at www.sennheiser.com.

Product overview

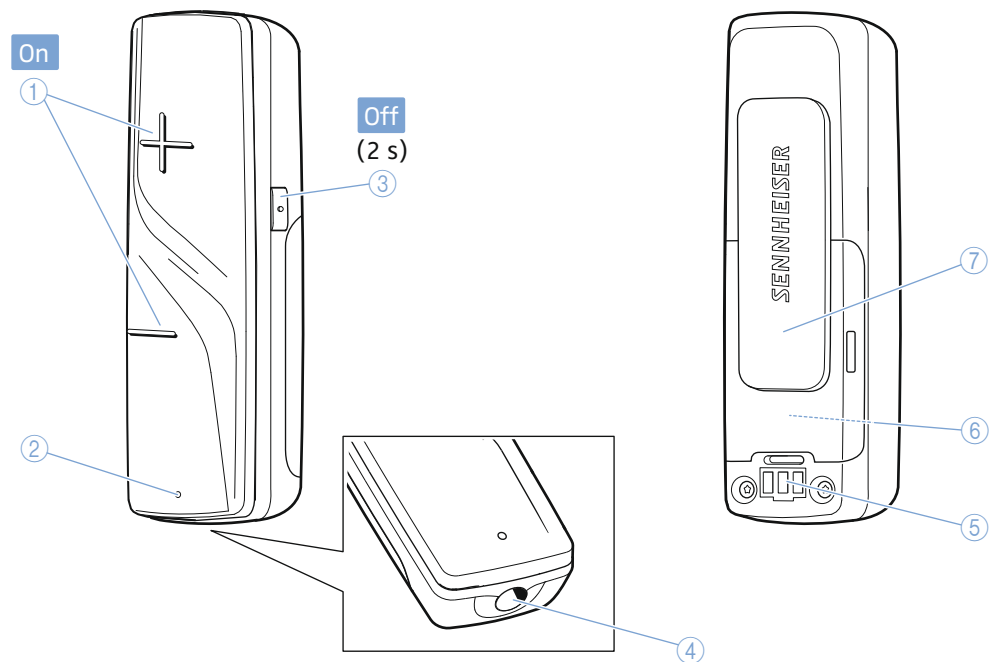

Overview of the RR Flex receiver



- ① Volume buttons + and – and for switching the receiver on
- ② *Receiver status* LED (see page 9)
- ③ *Speech intelligibility* button and for switching the receiver off (press for 2 seconds)
- ④ 3.5 mm jack socket for connecting headphones or and induction loop for hearing aids
- ⑤ Charging contacts
- ⑥ Built-in rechargeable battery
- ⑦ Attachment clip

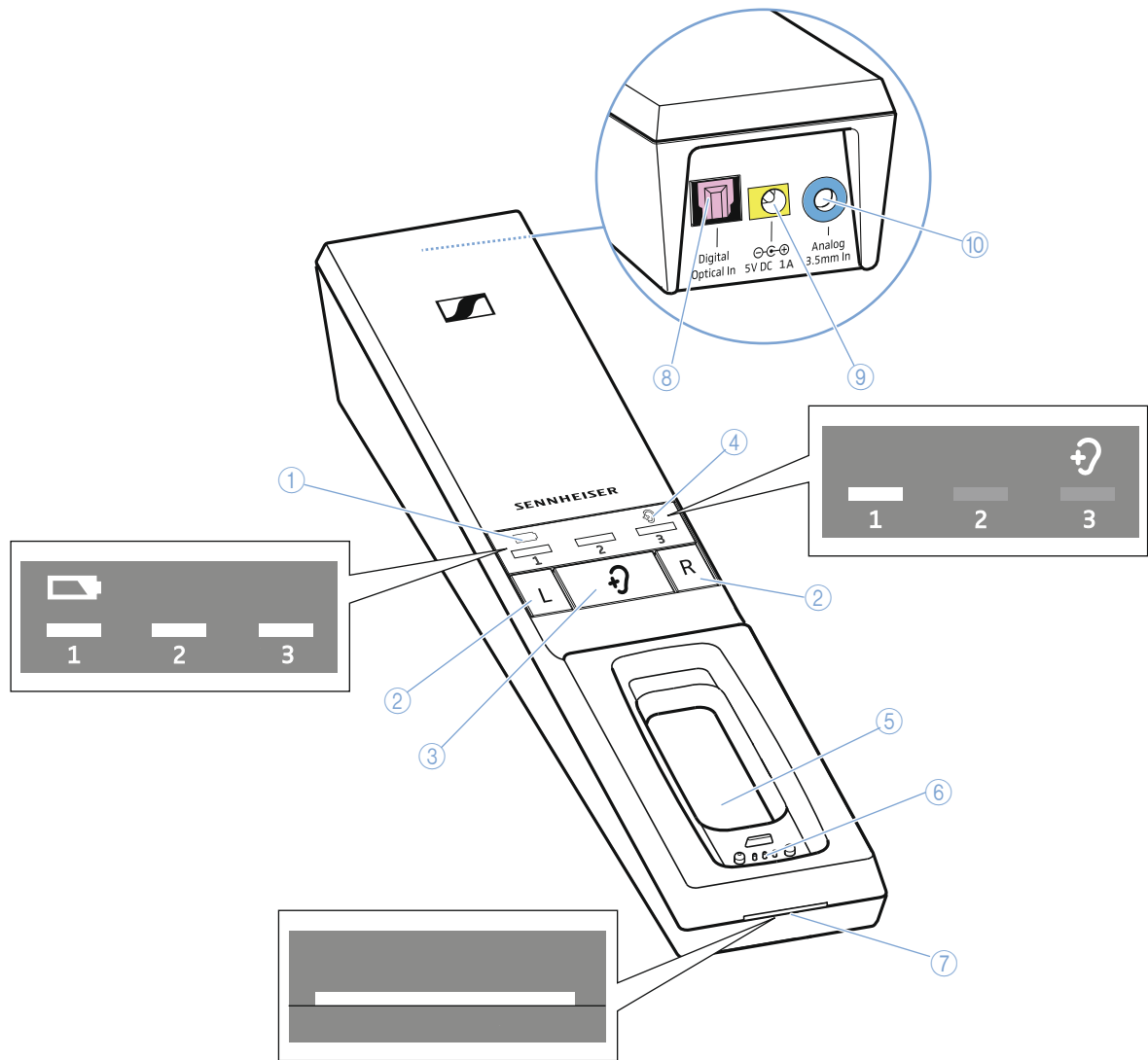





Overview of the TR 5000 transmitter

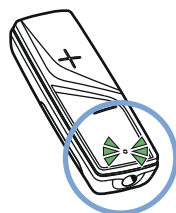

- ① **Battery LED** , indicating the charging process/remaining operating time of the receiver (see page 16 and 17)
- ② Balance buttons for right ear **R** and left ear **L**
- ③ **Hearing profile** button  for selecting the hearing profiles (see page 23)
- ④ **Hearing profile LED** , indicating the activated hearing profile (see page 23)
- ⑤ Charging compartment for receiver
- ⑥ Charging contacts for receiver with holding magnets
- ⑦ **Transmitter status LED** (see page 9)
- ⑧ **Digital Optical In** audio input (marked pink) for connecting a digital audio source (optical)
- ⑨ **5V DC 1A** socket (marked yellow) for connecting the power supply unit
- ⑩ **Analog 3.5 mm In** audio input (marked blue) for connecting an analog audio source (3.5 mm jack socket)





Overview of the Receiver status LED

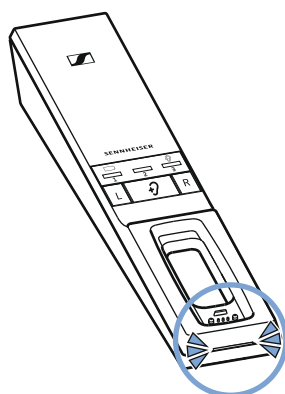

Receiver status LED	The receiver...
—	... is switched off.
 ————— ... lights up green	... is connected to the transmitter.
 ————— ... lights up red	... is connected to the transmitter, the rechargeable battery is almost empty.
 ○ ○ ○ ○  ○ ○ ○ ○ 1s 1s ... flashes green	... is not connected to the transmitter or cannot connect to the transmitter.
 ○ ○ ○ ○  ○ ○ ○ ○ 1s 1s ... flashes red	... is not connected to the transmitter or cannot connect to the transmitter, the rechargeable battery is almost empty.

Overview of the Transmitter status LED



Transmitter status LED	The transmitter...
—	... is in standby mode.
 ————— ... lights up white	... and the stethoset receiver are connected. The speech intelligibility function is deactivated (see page 25).
 ————— ... lights up blue	... and the stethoset receiver are connected. The speech intelligibility function is activated (see page 25).
  ————— ... flashes blue and white	... has detected an incompatible digital audio signal (see page 12).

i The LEDs on the receiver and on the transmitter indicate the current operating state. If you are not pressing any button on the receiver, the LEDs automatically dim after approx. 30 seconds to not disturb you.

Overview of the acoustic signals/beeps



Beeps...	Meaning
during operation, 2 beeps	The rechargeable battery is almost empty, recharge it (see page 16).
during operation, no audio transmission, 5 beeps	The receiver is outside the transmission range (see page 35).
when changing the volume	The maximum or minimum volume is reached (see page 21).
when changing the balance setting	The maximum or minimum balance setting is reached (see page 22).

Putting the Flex 5000 into operation

Setting up the transmitter

- ▶ Choose a suitable place near your sound source.
- ▶ Separate the transmitter from other wireless devices in the room by at least 50 cm/20" to avoid interference.
- ▶ Do not place the transmitter close to metal objects such as shelf bars, reinforced concrete walls, etc. as this can decrease the transmitter's range.











Connecting the transmitter to an audio source

You can connect the transmitter either to a digital or an analog audio source (e.g. a TV and a stereo hi-fi system).

If you connect an audio source to **both** inputs (digital and analog), only the analog audio source will be reproduced.

 You can also refer to the beginner's video guides on how to connect your digital wireless headphone system to a TV: www.sennheiser.com/how-to-videos.

- ▶ Switch your audio sources off before connecting the transmitter.
- ▶ Check the connection possibilities of your audio source (audio output, usually marked "OUT").
- ▶ Select the corresponding connection cable and, if necessary, a suitable adapter
- ▶ To connect the transmitter to your audio source, refer to the connection diagram suitable for your audio source (see the following chapters). Follow the color codings on the transmitter and on the cables.

Connection possibilities of the audio source			Color coding on the transmitter	Connection cable	Page
A	Optical (digital)			Optical digital cable	12
B	3.5 mm jack socket (analog)			Stereo audio cable	13
C	RCA (analog)			Stereo audio cable with RCA adapter (3.5 mm jack socket to 2 RCA plugs; optional accessory)	14
D	SCART (analog)			Stereo audio cable with SCART adapter (3.5 mm jack socket to SCART connector; optional accessory)	14

 Accessories and adapters are available from your local Sennheiser partner.

A

Connection possibility A: optical (digital)

To achieve the best possible listening experience, connect the transmitter to your TV or hi-fi system using the supplied optical digital cable.

Note that your wireless headphone system only supports digital signals coded in the **PCM** format. Information on how to set the audio format of the connected audio source to PCM can be found in the Sound menu or in the instruction manual of your device.

If an incompatible digital audio signal is being received, the *Transmitter status* LED flashes white and blue. Audio cannot be reproduced.

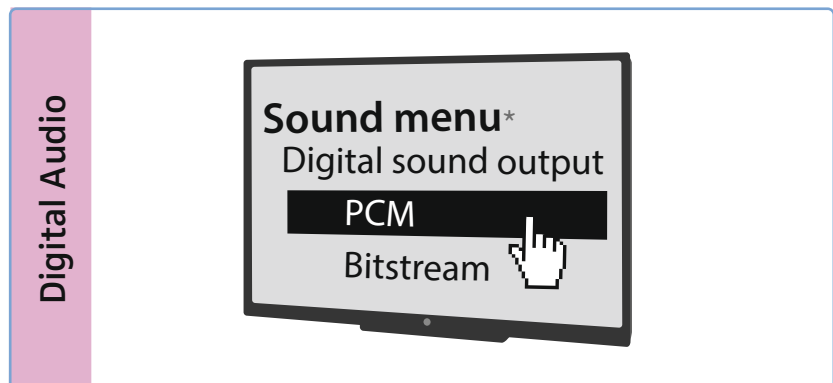

* The appearance of the Sound menu can vary depending on the device you are using.

- ▶ Connect the optical digital cable to the pink **Digital Optical In** audio input of the transmitter and to the optical output of your audio source.

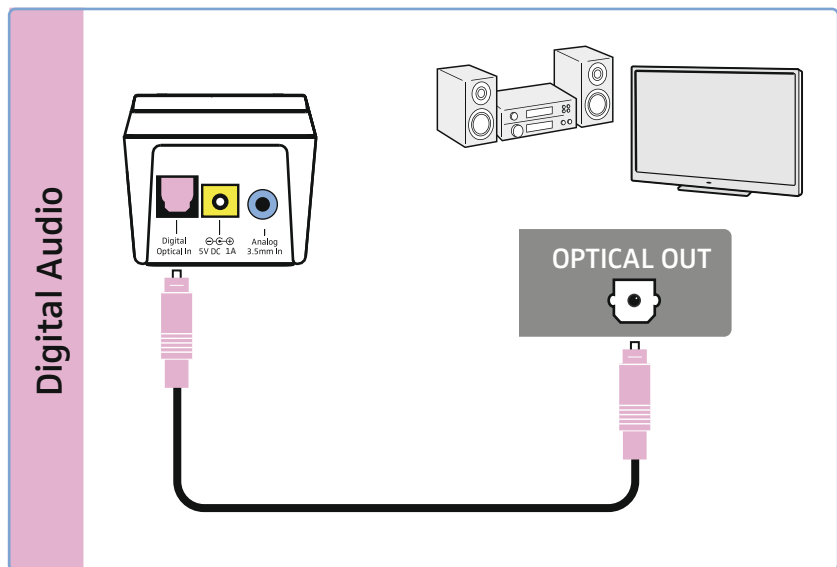

B**Connection possibility B: 3.5 mm jack socket (analog)**

- ▶ Connect the stereo audio cable to the blue **Analog 3.5 mm In** audio input (3.5 mm jack socket) of the transmitter and to the 3.5 mm headphone socket of your audio source.

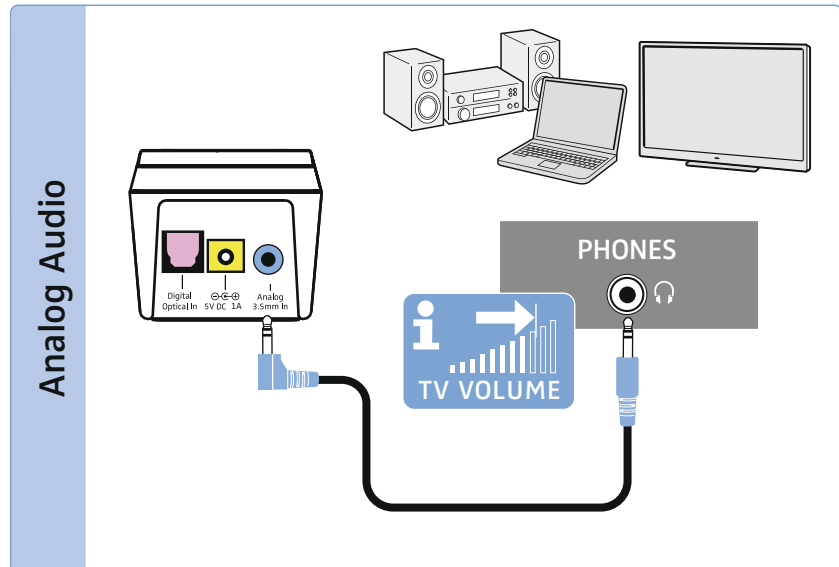

- i** Adjust the volume of the headphone socket on your TV/audio source to at least a **medium level**.

This improves the quality of wireless audio transmission. For detailed information, please refer to the instruction manual of your TV/audio source.

If the headphones socket on your audio source is a 6.3 mm/1/4" jack socket, you require an adapter (3.5 mm jack plug to 6.3 mm/1/4" jack plug, optional accessory) for the supplied 3.5 mm stereo audio cable.

Some TV models mute the loudspeakers when you connect the transmitter to the 3.5 mm headphone socket. Other TV models have their own menu for adjusting the volume of the headphone socket. Check the menu of your TV for information on how to deactivate the muting function or adjust the volume. Alternatively, connect the TV and the transmitter using a different connection possibility (A, C or D).

C

Connection possibility C: RCA sockets (analog)

- ▶ Plug the RCA adapter* onto the stereo audio cable.
- ▶ Connect the stereo audio cable to the blue 3.5 mm jack socket of the transmitter.
- ▶ Connect the RCA connectors to the RCA sockets (mostly labeled "AUDIO OUT" or $\ominus \rightarrow$) of your audio source. Connect the red connector to the red RCA socket and the white connector to the white or black RCA socket.

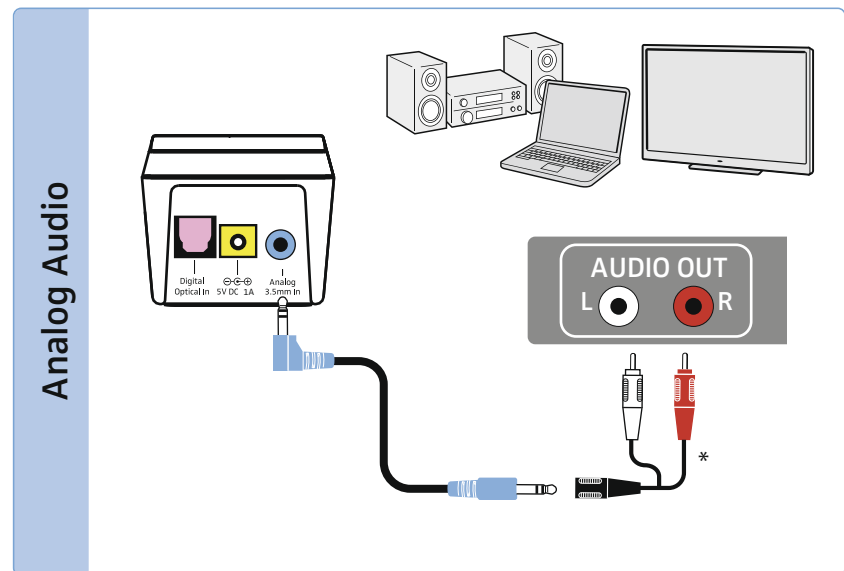

* optional accessory

D

Connection possibility D: SCART socket (analog)

- ▶ Plug the SCART adapter* onto the stereo audio cable.
- ▶ Connect the stereo audio cable to the blue 3.5 mm jack socket of the transmitter.
- ▶ Connect the SCART connector to the SCART socket (mostly labeled $\boxleftarrow \rightarrow$ or \boxrightarrow) of your audio source.

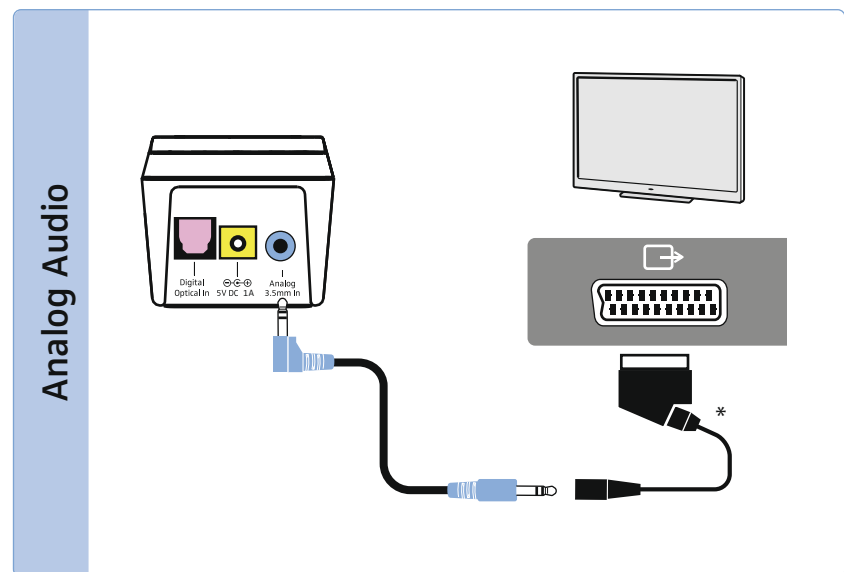

* optional accessory

Connecting the transmitter to the power supply system

- 1 Connect the connector of the power supply unit to the yellow socket of the transmitter.
- 2 Select a suitable country adapter and slide it onto the power supply unit until it clicks audibly into place.
- 3 Plug the power supply unit into the wall socket.
All LEDs on the transmitter light up for 5 seconds. The transmitter is in standby mode.

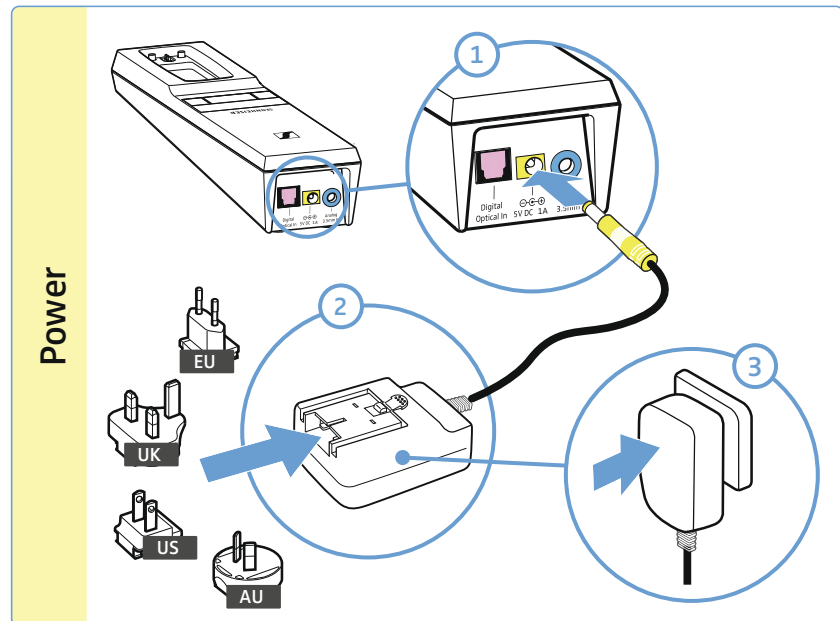

Charging the receiver's rechargeable battery







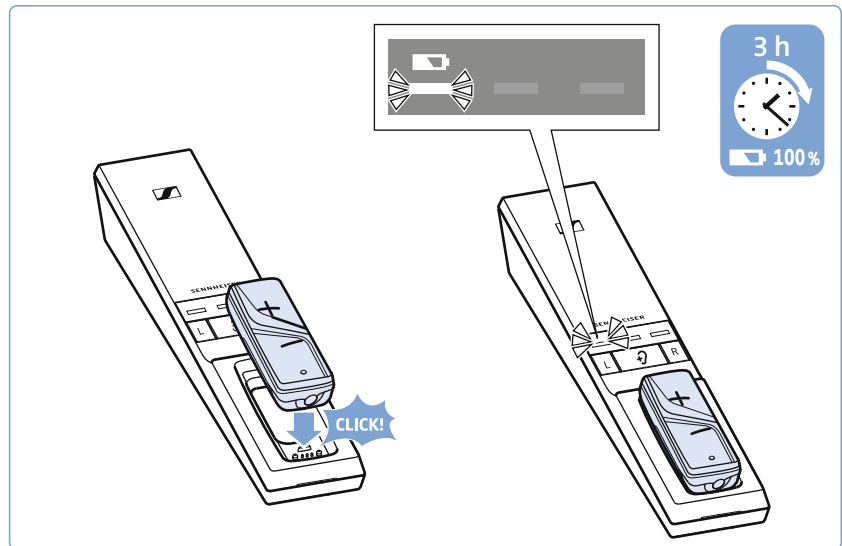

A complete charging cycle takes about 3 hours. Before using the receiver for the first time, charge its rechargeable battery for a complete charging cycle without interruption.

When the rechargeable battery is almost empty, the *Receiver status* LED lights up red and you hear 2 beeps via the receiver. The *Battery* LED  on the transmitter lights up white. The receiver switches off after a few minutes.

- ▶ Place the receiver into the transmitter's charging compartment so that the volume buttons face upwards. The receiver is magnetically oriented to the correct position. The receiver automatically switches off and the *Battery* LED  on the transmitter lights up white. The LED segments display the charge status of the rechargeable battery. When the rechargeable battery is fully charged, all LED segments light up white.









Battery LED 	Meaning
 –	The transmitter is not charging.
 1 st LED segment flashes	The rechargeable battery is being charged. Less than one-third of the charge capacity is reached.
 1 st LED segment lit 2 nd LED segment flashes	The rechargeable battery is being charged. Up to one-third of the charge capacity is reached.
 1 st + 2 nd LED segments lit 3 rd LED segment flashes	The rechargeable battery is being charged. Up to two-thirds of the charge capacity is reached.
 All LED segments lit	The rechargeable battery is fully charged.
 <i>Battery</i> LED flashes rapidly	A charging error/battery error has occurred (see page 26).

i Always store the receiver in the transmitter’s charging compartment to ensure that it is fully charged when needed. The intelligent battery charging technology prevents overcharging.

i The display during charging can be set so that it automatically switches off after 30 seconds (see page 29).

Displaying the remaining operating time of the rechargeable battery

When you switch the receiver on, the Battery LED  displays the remaining operating time/charge status.

BatteryLED 		Meaning
	BatteryLED flashes slowly	Rechargeable battery is empty; recharge it
	1 st LED segment lit	approx. 4 hours of operating time
	1 st + 2 nd LED segments lit	approx. 8 hours of operating time
	All LED segments lit	approx. 12 hours of operating time

To indicate that the operating time is decreasing, each LED segment slowly dims before it goes off completely.

If the actual operating time differs widely from the specified values, the rechargeable battery is probably exhausted and should be replaced. Information on the rechargeable battery can be found on page 26.

i The display of the remaining operating time can be set so that it automatically switches off after 30 seconds (see page 29).

i If more than one receiver is connected to the transmitter, the remaining operating time/charge status cannot be displayed.

Using the charging reminder function



When the receiver is switched off and the transmitter automatically switches off (standby mode), the BatteryLED  will flash back and forth for 10 minutes to remind you to charge the receiver.

- ▶ Charge the receiver by placing it into the transmitter’s charging compartment (see page 16).
The LED stops flashing and the charging process starts.

i You can also switch off the charging reminder function (see page 29).

Using the Flex 5000

Connecting headphones or an induction loop to the receiver

You can connect any headphones or induction loop for hearing aids with a 3.5 mm jack plug to the RR Flex receiver.

Connecting headphones

We recommend using closed headphones or earphones/ear canal phones to avoid echoes from e.g. the TV loudspeaker.

- ▶ Connect the 3.5 mm jack plug of the headphones (e.g. MX 475, supplied) to the jack socket of the receiver.

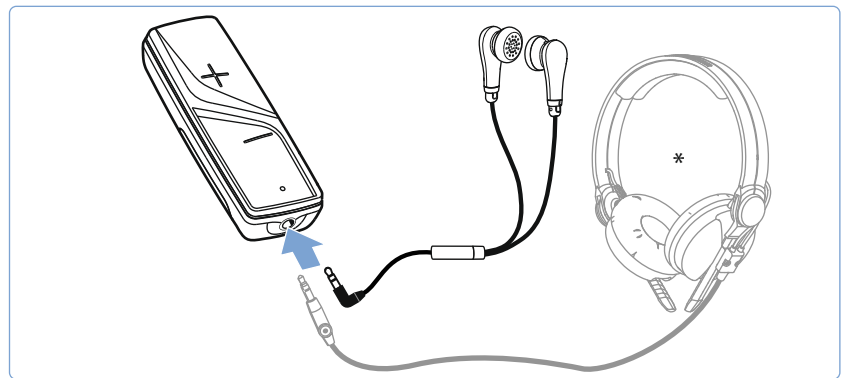

Connecting an induction loop for hearing aids

You can only use an induction loop if your hearing aid supports an induction coil (T-coil).

- ▶ Connect the 3.5 mm jack plug of the induction loop (e.g. Sennheiser EZT 3012, optional accessory) to the jack socket of the receiver.

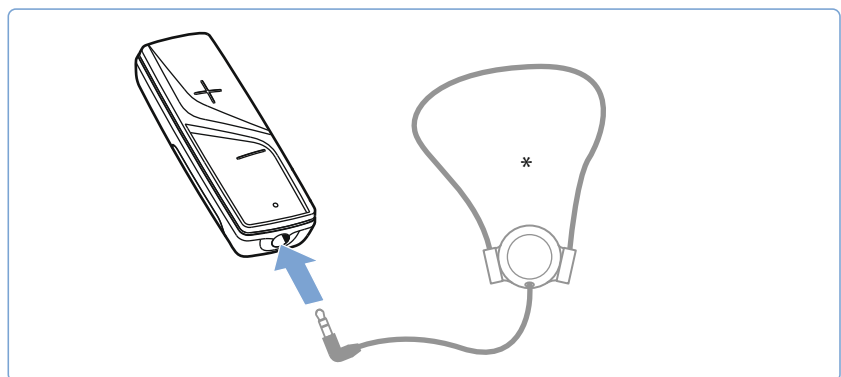

- ▶ Set your hearing aid to position "T".

i If your hearing aid has no position "T" or if you want to use another connection possibility for your hearing aid or cochlea implant, please contact your hearing aid acoustician.

* optional accessory

Switching the wireless headphone system on

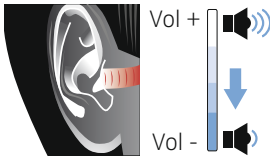

WARNING

Danger of hearing damage due to high volumes!

This receiver allows you to set higher volumes than conventional devices. Constant high-volume use can cause hearing damage.

- ▶ Before putting the receiver and the connected headphones on, set the volume on the receiver to a low level.
- ▶ Do not expose yourself to high volume levels for extended periods of time.
- ▶ Use a hearing profile (see page 23) that improves especially speech intelligibility without the need for a high volume.

1 Switch your audio source on.



If the transmitter is connected to the headphone socket (see page 13) of your TV/audio source, adjust the volume of the headphone socket on your TV/audio source to at least a medium level.

2 Take the receiver out of the transmitter's charging compartment and press the volume button + or –.

The receiver switches on. The *Receiver status* LED lights up green. The transmitter automatically switches on and the *Transmitter status* LED lights up white or blue. The audio transmission starts.

The remaining operating time of the receiver is displayed on the transmitter (see page 17).

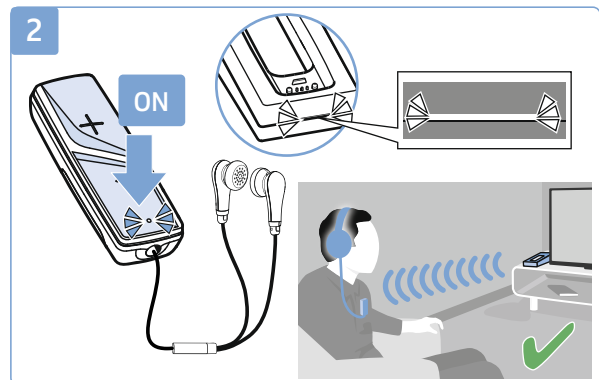
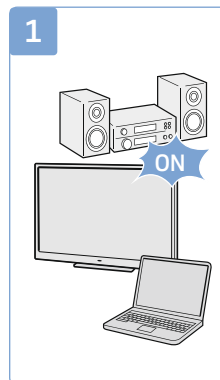

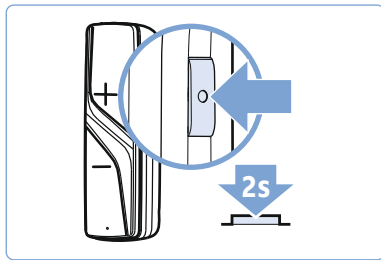
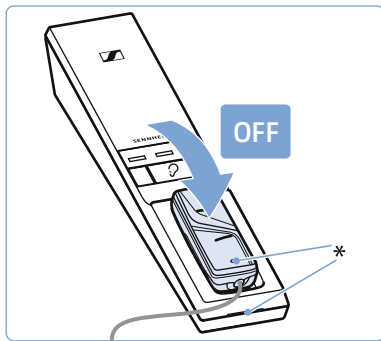

* LED goes off

Switching the wireless headphone system off

- ▶ Place the receiver into the transmitter's charging compartment. The receiver switches off. The *Receiver status* LED goes off. The charging process starts (see page 16).

Or, if you want to switch the receiver off without placing it into the transmitter's charging compartment:

- ▶ Press the *Speech intelligibility* button for 2 seconds. The receiver switches off. The *Receiver status* LED goes off. The transmitter automatically switches off (standby) when there is no receiver connected. The *Transmitter status* LED goes off.

i Always store the receiver in the transmitter's charging compartment to ensure that it is fully charged when needed.

i If the receiver is outside the transmission range for more than 5 minutes or if the transmitter receives no audio signal for more than 30 minutes, the wireless headphone system switches off automatically (standby).

To disconnect the transmitter from the power supply system (e.g. when you are on holiday):

- ▶ Unplug the power supply unit from the wall socket.

Attaching the receiver to clothing

Depending on the connected headphones or induction loop, please observe the following attachment recommendations for your receiver:

- Place the receiver next to you so that you can take it in your hand and operate it.

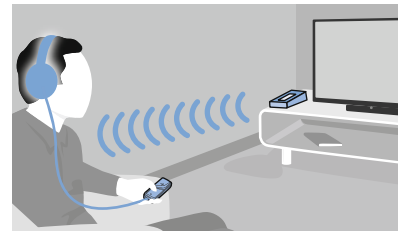

- Use the clip to attach the receiver to your clothing. Make sure that the headphone cable does not hinder your movements and that there is a free line of sight between the receiver and the transmitter. The volume buttons face away from your body to facilitate ease of use.

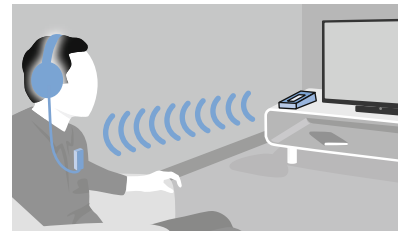

- Place the induction loop around your neck so that the receiver rests on your chest. The volume buttons face away from your body to facilitate ease of use.

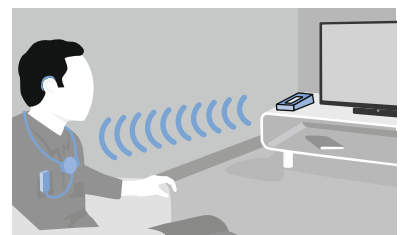

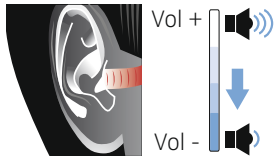

Adjusting the volume



WARNING

Danger of hearing damage due to high volumes!

- ▶ Before putting the receiver and the connected headphones on, set the volume on the receiver to a low level.
 - ▶ Do not expose yourself to high volume levels for extended periods of time.
-
- ▶ Press the volume button + or the volume button – until the volume is adjusted to a comfortable level. When the minimum or maximum volume is reached, you hear a beep via the receiver.

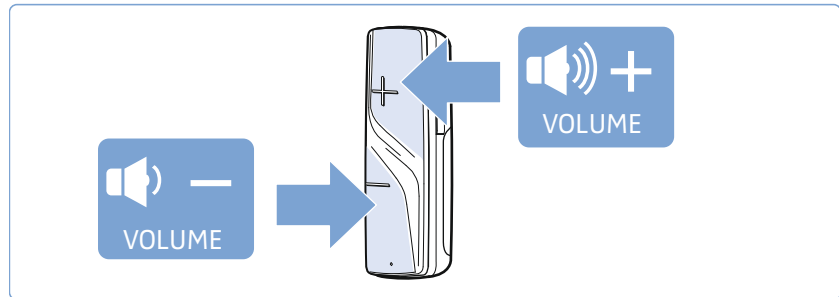

If you have set a very high volume level and switch the receiver off and on again, the volume is reset to a moderate level to protect your hearing.

Adjusting the balance

The balance buttons allow for left/right volume adjustment. Adjust the balance so that you hear equally well with both ears.

i The balance setting is stored on the receiver. If you are using several receivers with a transmitter, the respective receivers are optimally adjusted to match the personal hearing preferences of the users (e.g. you and your partner). Please note that the personal hearing preferences can only be adjusted when only receiver is connected to the transmitter.

- ▶ Press the balance button **R** (right) or **L** (left) on the transmitter to gradually increase or reduce the volume for your right or left ear.
When the minimum or maximum balance setting is reached, you hear a beep via the receiver.

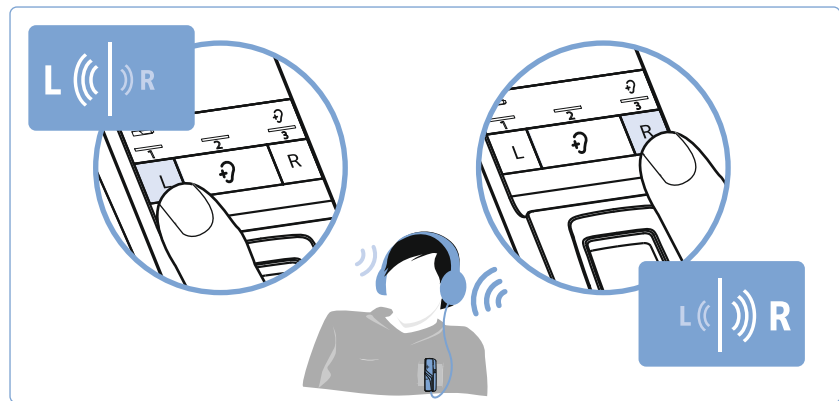

To reset the balance setting to the middle setting:

- ▶ Simultaneously press the balance buttons **R** (right) and **L** (left) on the transmitter for 3 seconds.

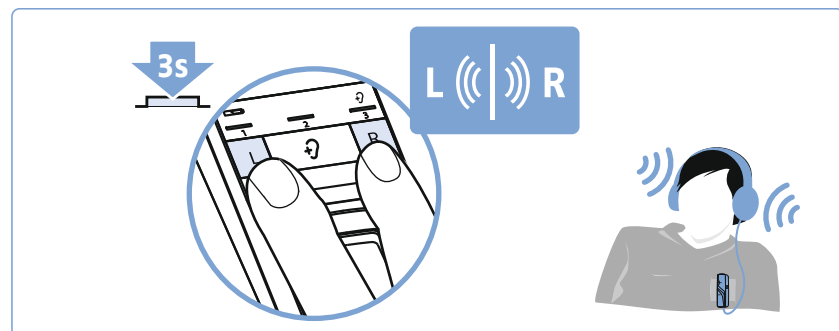

i To prevent accidental adjustment of the balance settings, you can activate the balance protection (see page 30).

Selecting a hearing profile for sound enhancement

The hearing profiles alter the sound of the audio signal in order to especially improve the speech intelligibility. The profiles are used to specifically change certain frequency ranges by e.g. boosting or attenuating low-frequency or high-frequency tones.

All three hearing profiles feature a compression function which compensates for volume differences by boosting the volume of quiet passages and reducing the volume of loud passages if necessary.

i The balance setting is saved on the receiver. If you are using several receivers with a transmitter, the respective receivers are optimally adjusted to match the personal hearing preferences of the users (e.g. you and your partner). Please note that the personal hearing preferences can only be adjusted when only receiver is connected to the transmitter.





Displaying the activated hearing profile

The activated hearing profile is not permanently displayed.

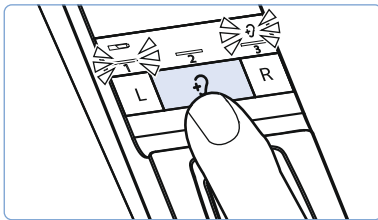
To check the activate hearing profile:

- ▶ Switch your receiver on (see page 19).
- ▶ Briefly press the *Hearing profile* button on the transmitter. The currently activated hearing profile is displayed for 10 seconds.



Activated hearing profile	Hearing profile LED 	Sound enhancement	Compression
–	 No LED segment lit	The sound from the connected audio source is reproduced unchanged.	no
Hearing profile 1	 1 st LED segment lit	Low-frequency tones are slightly boosted to provide a warm, full sound. High-frequency tones are reproduced less piercing and clanking.	yes
Hearing profile 2	 2 nd LED segment lit	High-frequency tones are strongly boosted to provide a crystal-clear sound, especially for sibilants and high-frequency tones such as twittering of birds.	yes
Hearing profile 3	 3 rd LED segment lit	Low-frequency tones are attenuated so that they cannot mask high-frequency tones.	yes

i A graphic representation of the hearing profiles can be found on page 37.

Selecting a hearing profile

To select the hearing profile that best suits you, proceed as follows:

- 1 Switch your audio source on and select a program where speech is foregrounded.

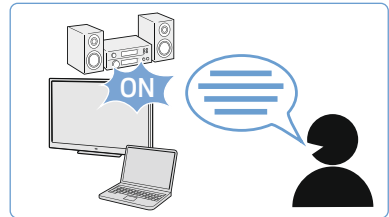

- 2 Put the headphones connected to the receiver on and make sure that only this receiver is connected to the transmitter. Otherwise, a hearing profile cannot be adjusted.

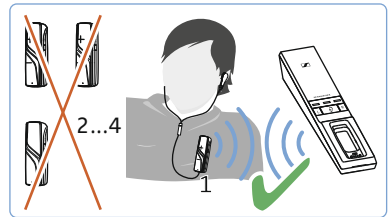

- 3 Use the **L** and **R** buttons on the transmitter to adjust the balance (see page 22). This ensures that each subsequently selected hearing profile is perfectly matched to your left/right balance setting.

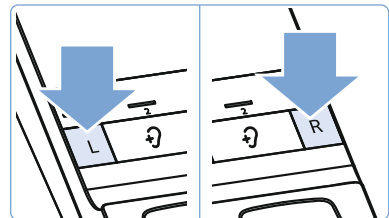

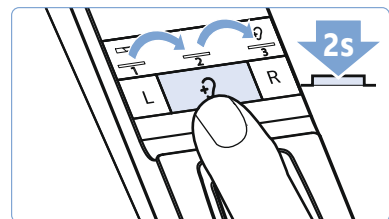

- 4 Press the *Hearing profile* button on the transmitter for 2 seconds to select the next hearing profile. Press the *Hearing profile* button again for 2 seconds to switch to the next hearing profile.

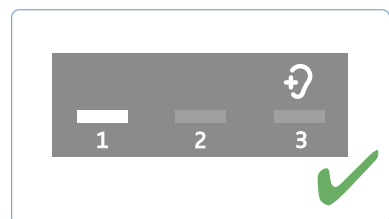

- 5 Test which of the hearing profiles (1, 2 or 3) gives you the best sound quality and helps you to hear best. Your individual hearing profile is adjusted and saved on the receiver.



-  Since your level of hearing impairment may change over time, we recommend that you repeat the selection of the hearing profile from time to time.
-  If you switch to the next hearing profile, the speech intelligibility function is automatically deactivated so that you can hear the hearing profile unchanged (see page 25).
-  To prevent accidental adjustment of the hearing profile settings, you can activate the hearing profile protection (see page 30).

Activating/deactivating the speech intelligibility function

When speech is mixed with annoying background noise, speech may be difficult to understand.



The speech intelligibility function automatically detects and reduces annoying background noise. The audio signal is permanently analyzed and adjusted accordingly so speech is foregrounded and easier to understand.

Application examples

Application	Speech intelligibility function	Advantage
TV motion pictures, TV series or audio books	activated	Dialogs muffled by background music and noise are easier to understand.
Sportscasts	activated	The presentation muffled by background noise in the stadium is easier to understand.
Music	deactivated	No speech, the speech intelligibility function is not needed.

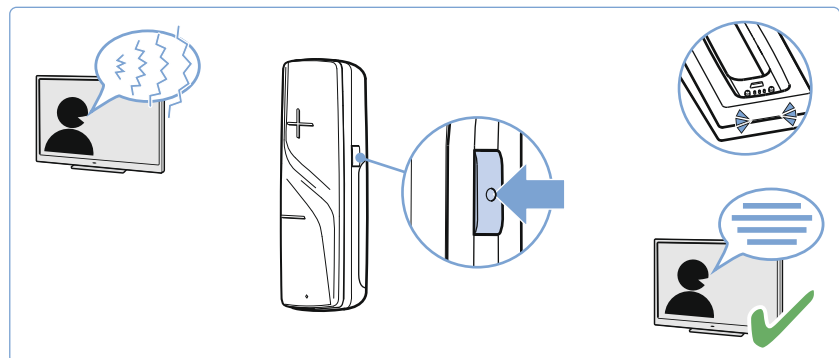
- ▶ Press the *Speech intelligibility* button to activate or deactivate the function.

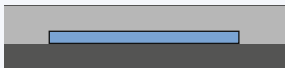

<i>Transmitter status</i> LED	Speech intelligibility function
 lights up blue	activated Annoying background noise is effectively reduced, speech becomes clearer and easier to understand.
 lights up white	deactivated

-  The speech intelligibility function can also be used in addition to one of the hearing profiles 1-3.

Cleaning and maintaining the Flex 5000

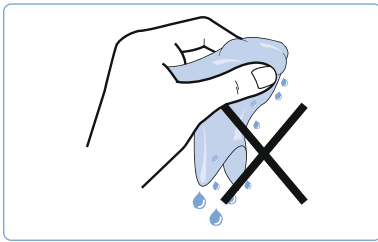

CAUTION

Liquids can damage the electronics of the product!

Liquids entering the housing of the product can cause a short-circuit and damage the electronics.

- ▶ Keep all liquids far away from the product.
- ▶ Do not use any solvents or cleansing agents.

To clean the wireless headphone system:

- ▶ Switch your wireless headphone system off and disconnect the transmitter from the socket before cleaning.
- ▶ Clean the product only with a soft, dry cloth.
- ▶ Clean the charging contacts on the receiver and in the charging compartment from time to time using e.g. a cotton swab.

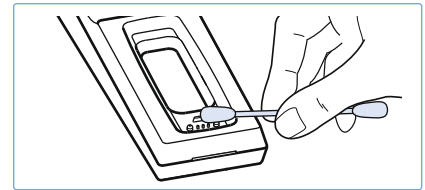
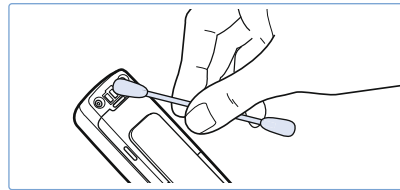

Replacing the receiver's rechargeable battery

The BAP 800 rechargeable battery of the receiver is compactly built into the receiver housing and does not have to be replaced or removed.

If the operating time of the receiver decreases drastically or if a charging error is displayed during charging (see page 16), the rechargeable battery may be exhausted or defective and has to be replaced.

CAUTION

Danger of damage to the product!

During the warranty period, the rechargeable batteries must only be replaced or removed by an authorized Sennheiser service partner, otherwise the warranty will be null and void.

- ▶ Contact your Sennheiser service partner if the rechargeable batteries need to be replaced or removed.

Outside the warranty period, the rechargeable batteries may be replaced or removed by any qualified service center in an appropriate manner. Instructions on how to replace or remove the batteries for qualified service centers are available from the Sennheiser service partner.

You need suitable tools for replacement. We therefore recommend to have the rechargeable battery replaced by your Sennheiser service partner. To find a Sennheiser service partner in your country, search at www.sennheiser.com.

Using additional functions

The following additional functions are not required for normal use of the wireless headphone system. You can, however, extend the potential use of the system and adjust some of the functions to your individual needs.

Pairing one or several receivers with the transmitter

The receiver and the transmitter of your wireless headphone system are factory pre-paired. The following steps are only necessary if you want to pair additional receivers with the transmitter.

You can simultaneously use up to 4 paired receivers with your transmitter. All other paired and switched-on receivers cannot connect to the transmitter.

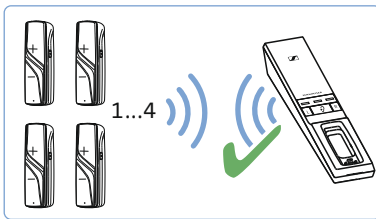

i If more than one receiver is connected to the transmitter, the remaining operating time/charge status and the hearing profile cannot be displayed. In addition, the balance and a hearing profile cannot be adjusted. These functions can only be used/adjusted when only one receiver is connected to the transmitter.

Option A (contact pairing)

- ▶ Place the receiver into the transmitter's charging compartment. The receiver is paired with the transmitter.

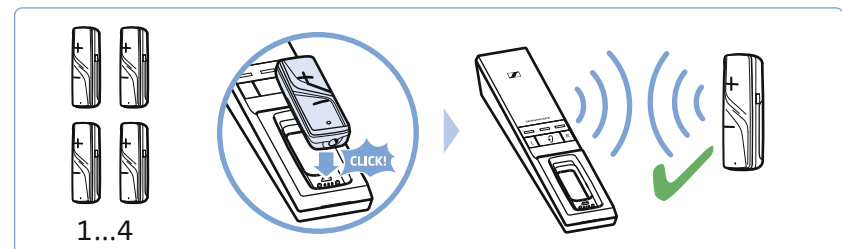

Option B (proximity pairing)

- 1 Place the receiver as close as possible to the transmitter.
- 2 Simultaneously press and hold the volume buttons +/- until the *Receiver status* LED flashes red. Once pairing is completed, the *Receiver status* LED flashes green and the *Transmitter status* LED flashes white. Release the buttons.

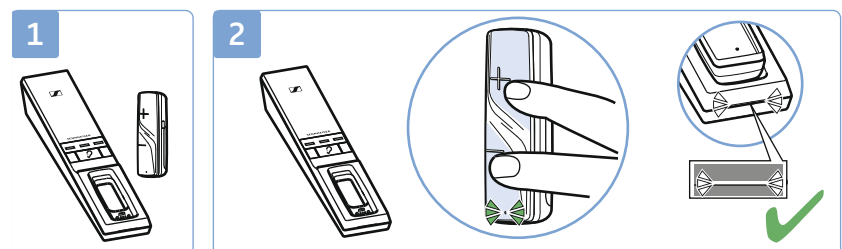

Advanced settings

The advanced settings allow you to adjust the wireless headphone system to your individual needs and to protect the settings against accidental changes.

Activating the protected settings mode

You can change the advanced settings by activating the protected settings mode:

- 1 Disconnect the transmitter from the power supply system by unplugging the connector of the power supply unit.
- 2 Keep the *Hearing profile* button pressed and connect the transmitter to the power supply system by connecting the connector of the power supply unit to the yellow socket of the transmitter.

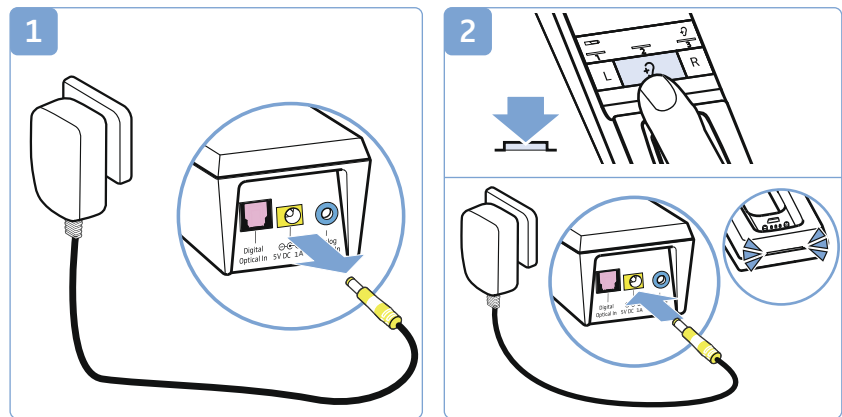

The protected settings mode is activated. The *Transmitter status* LED flashes blue. The LED segments indicate the current settings as specified in the following chapters:

- battery status display (see page 29)
- charging reminder function (see page 29)
- hearing profile and balance protection (see page 30)

Deactivating the protected settings mode and saving the advanced settings

To save the advanced settings and to deactivate the protected settings mode:

- 3 Disconnect the transmitter from the power supply system by unplugging the connector of the power supply unit.

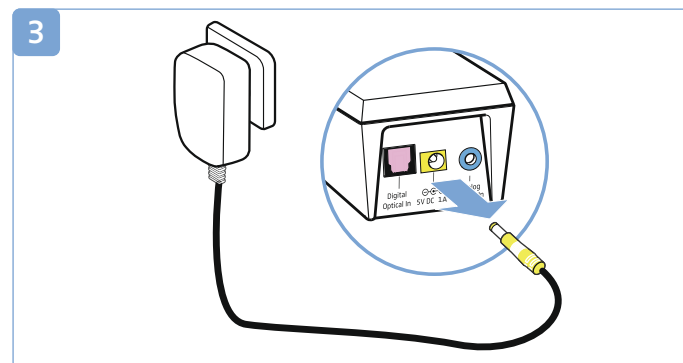

Battery status display

This setting is saved on the **transmitter**, independent of the receiver you are using.

To change the battery status display:

- ▶ Make sure that the protected settings mode is activated (see page 28).
- ▶ Press the Balance button **L**.

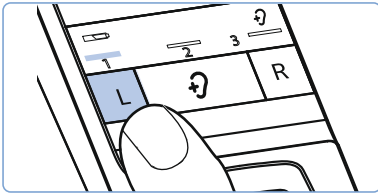

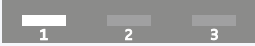
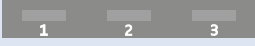
Status and display of the <i>Battery</i> LED	Function/behavior
permanently activated (operation and charging)*  1 st LED segment lit	The current charge status is permanently displayed during charging. The remaining charge status is permanently displayed during operation.
activated for 30 seconds (operation and charging)  1 st LED segment off	The current charge status is displayed for 30 seconds during charging. Then all LEDs go off. The charging process is continued. The remaining charge status is displayed for 30 seconds during operation. The battery status display then goes off.

* factory setting

- ▶ Save the setting by disconnecting the transmitter from the power supply system (see page 28).



Charging reminder function

This setting is saved on the **transmitter**, independent of the receiver you are using.

To activate or deactivate the function:

- ▶ Make sure that the protected settings mode is activated (see page 28).
- ▶ Press the Balance button **R**.



Status and display of the charging reminder function	Function/behavior
activated*  3 rd LED segment lit	When you switch the receiver off and the transmitter switches to standby mode, the battery status display will flash for 10 minutes to remind you to charge the receiver.
deactivated  3 rd LED segment off	After switching the wireless headphone system off, all LEDs remain off.

* factory setting



- ▶ Save the setting by disconnecting the transmitter from the power supply system (see page 28).

Hearing profile and balance protection

This setting is saved on the receiver, independent of the transmitter you are using.

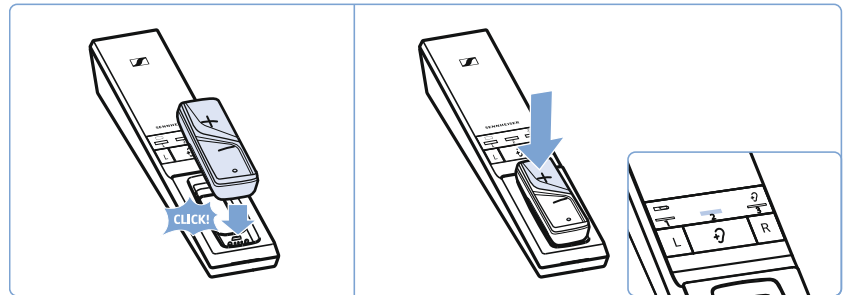
- ▶ Make sure that your receiver's balance setting and hearing profile are correctly adjusted (see page 22 and 23).
- ▶ Make sure that the protected settings mode is activated (see page 28).
- ▶ Place the receiver into the transmitter's charging compartment.
- ▶ Press the volume button + on the receiver to activate or deactivate the hearing profile and balance protection.



Status and display of the protection function	Function/behavior
activated  2 nd LED segment lit	The activated hearing profile and the balance setting cannot be changed/deactivated.
deactivated*  2 nd LED segment off	The hearing profiles can be changed at any time by pressing the <i>Hearing profile</i> button for 2 seconds. The balance setting can be changed.

* factory setting

- ▶ Save the setting by disconnecting the transmitter from the power supply system (see page 28).

i If you are using several receivers and want to protect the activated hearing profiles from accidental adjustment, you can place the receivers, one after the other, into the transmitter's charging compartment to activate the hearing profile and balance protection.

Restoring the factory default settings

To restore the transmitter to the factory settings:

- 1 Disconnect the transmitter from the power supply system by unplugging the connector of the power supply unit.
- 2 Simultaneously press and hold the buttons L,  and R.
- 3 Connect the transmitter to the power supply system by connecting the connector of the power supply unit to the yellow socket of the transmitter while keeping the 3 buttons pressed for at least 3 seconds.

All LEDs on the transmitter flash. The transmitter settings are restored to the factory settings.

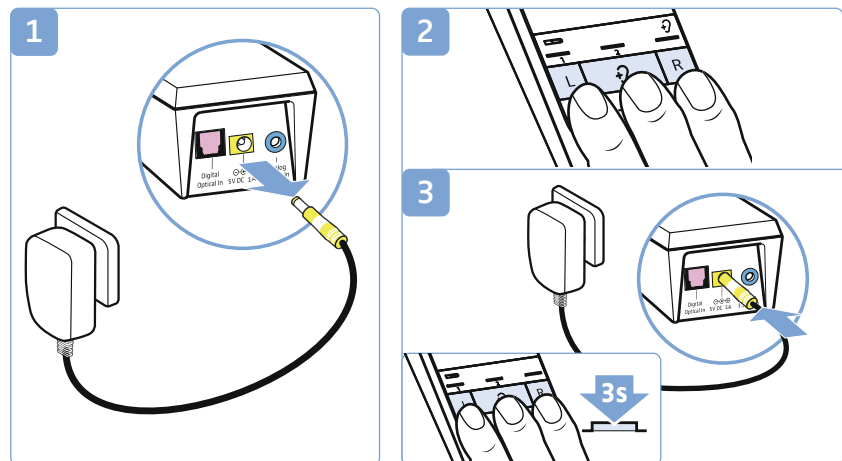

To restore a receiver to the factory settings:

- ▶ Place the receiver into the transmitter's charging compartment. The *Receiver status* LED flashes green. The settings of the receiver are also restored to the factory settings.

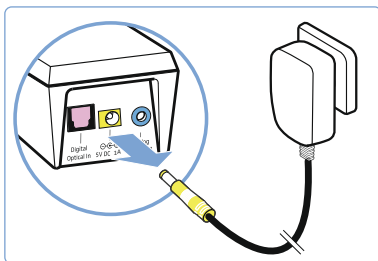
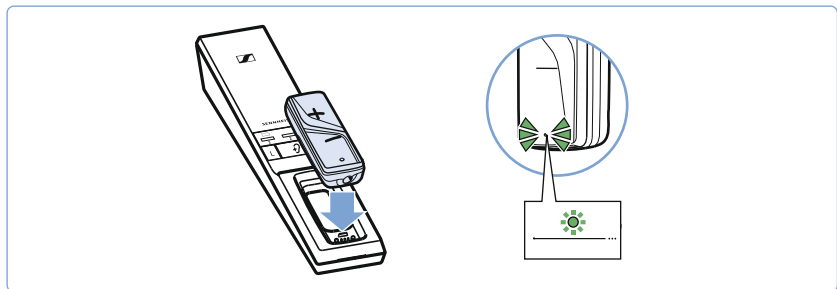

-  If you place the receiver into the transmitter's charging compartment at the very beginning of the restore procedure, the factory settings of the transmitter and the receiver are restored simultaneously.

- ▶ Disconnect the transmitter from the power supply system by unplugging the connector of the power supply unit. The factory settings are restored and you can use the wireless headphone system again.

Charging the rechargeable battery using the MCA 800 charging adapter

If you have purchased an additional receiver or an optional MCA 800 charging adapter, you can also charge the receiver using the charging adapter.



WARNING

Interference due to magnetic fields!

The MCA 800 charging adapter generates stronger permanent magnetic fields that could cause interference with cardiac pacemakers and implanted defibrillators (ICDs).

- ▶ Always maintain a distance of at least 3.94" (10 cm) between the holding magnets of the charging adapter and the cardiac pacemaker or implanted defibrillator.

- 1 Select a suitable country adapter and slide it onto the power supply unit until it clicks audibly into place.
- 2 Connect the connector of the power supply unit to the connection socket of the MCA 800 charging adapter.
- 3 Plug the power supply unit into the wall socket.
- 4 Connect the charging adapter to the charging contacts on the receiver. The charging adapter is magnetically oriented to the correct position.

The rechargeable battery is being charged. The LED on the charging adapter lights up red. When the rechargeable battery is fully charged, the LED lights up green.

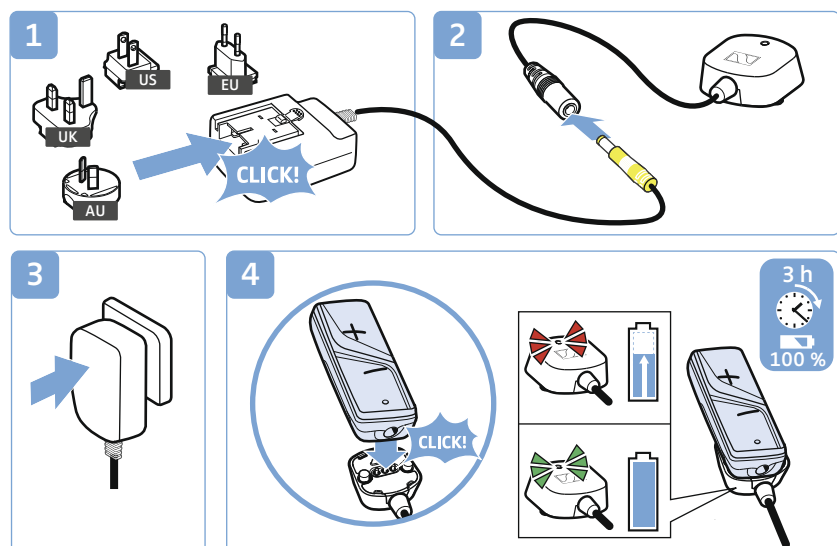

i You can also use the receiver during charging. Please note, however, that the receiver can get slightly warm during charging. The charge status of the rechargeable battery is displayed on the transmitter (see page 16).

If the LED on the charging adapter flashes red and green, a charging error/battery error has occurred. In this case, disconnect the charging adapter from the receiver. More information on the rechargeable battery can be found on page 26.

If a problem occurs ...

Problem	Possible cause	Possible solution	Page
The transmitter does not switch on	No connection to the power supply system.	Check the connections of the power supply unit.	15
The receiver cannot be switched on	The rechargeable battery is empty.	Recharge the rechargeable battery.	16
	The rechargeable battery is deep discharged.	Recharge the rechargeable battery for several hours. If the rechargeable battery is deep discharged, the charging process might take a while to start (up to 1 hour).	
No sound	No connection to the power supply system.	Check the connections of the power supply unit.	15
	The audio plug is not properly connected.	Check the audio plug connection.	11
	The audio source is switched off.	Switch the audio source on.	–
	The volume of the analog audio source is either set to the minimum or is on mute.	Increase the volume on the audio source to at least a medium level/ deactivate the muting function on the audio source.	–
	The audio cable is defective.	Replace the audio cable.	–
	The headphones are/induction loop is not correctly connected to the receiver.	Check the audio plug connection.	18
	The headphones are muted or the headphone volume is adjusted too low.	Check the settings of the headphones used.	–
	The receiver is not correctly paired with the transmitter (e.g. additional stethoset receiver/ receiver).	Pair the receiver with the transmitter again.	27
No audio signal when a digital audio source is connected	Cables are connected to both the digital and the analog audio input.	Remove the cable from the analog audio input.	11
	The connected digital audio source uses an incompatible audio format. The <i>Transmitter status</i> LED flashes white and blue.	Set the audio format of your audio source to "PCM", with a sampling rate of max. 96 kHz (see the instruction manual of the audio source).	–

Problem	Possible cause	Possible solution	Page
Occasional sound dropouts, it might be that you hear 5 beeps via the receiver	The receiver is out of the transmitter's range.	Reduce the distance between the receiver and the transmitter.	–
	The signal is shielded.	Remove obstacles between the transmitter and the receiver.	–
		Observe the attachment recommendations for your receiver.	20
	There are interfering devices (e.g. WiFi router, Bluetooth devices or microwaves) in the vicinity.	Change the position of the transmitter or of the receiver. Separate the transmitter from other wireless devices by at least 50 cm/ 20".	10
Sound too low	The volume on the receiver is adjusted to low.	Increase the volume on the receiver.	21
	The volume of the analog audio source is adjusted to low.	Increase the volume of the analog audio source to at least a medium level (approx. 1 V _{rms}).	–
	The headphones are muted or the headphone volume is adjusted too low.	Check the settings of the headphones used.	–
	The headphones used have a too high impedance/too low nominal sound pressure level.	Use low-impedance headphones or headphones with a high nominal sound pressure level.	–
Sound only on one ear	The balance is misadjusted.	Adjust the balance.	22
	The audio cable is not properly connected.	Check the audio plug connection.	11
	The TV has only a mono headphone socket.	Use an adapter (mono to stereo jack socket) to connect the transmitter to the TV.	–
Sound is distorted	The audio cable is defective.	Replace the audio cable.	–
	The signal of the audio source is distorted.	Reduce the volume of the audio source.	–
	The volume on the receiver is adjusted to high.	Reduce the volume on the receiver.	21
You hear echoes when using the stethoset receiver with a TV	You are using open headphones.	Use closed headphones or earphones/ ear canal phones.	–
	Some TVs can adjust a delay or latency of the audio signal for the digital audio output.	Check the audio output settings of your TV and set the latency to "0".	–
The battery status display goes off	The battery status display is set so that it goes off after 30 seconds.	Set the battery status display so that it is permanently displayed.	29
	More than one receiver is currently connected to the transmitter.	This function is only possible when only one stethoset receiver/receiver is connected to the transmitter.	–
2 beeps during operation	The rechargeable battery is almost empty.	Recharge the rechargeable battery.	16

Problem	Possible cause	Possible solution	Page
The operating time decreases	The rechargeable battery is exhausted.	Have the rechargeable battery replaced by an authorized Sennheiser service partner.	26
A hearing profile or the balance cannot be activated or changed	The hearing profile and balance protection is activated.	Deactivate the hearing profile and balance protection.	30
	More than one receiver is currently connected to the transmitter.	This function is only possible when only one stethoset receiver/receiver is connected to the transmitter.	–
The receiver does not connect to the transmitter	The receiver is not paired with the transmitter.	Pair the receiver with the transmitter.	27
	The distance to the transmitter is too large.	Reduce the distance between the receiver and the transmitter.	–
	4 receivers are currently connected to the transmitter.	Up to 4 stethoset receivers/receivers can be simultaneously used with the transmitter.	–

If a problem occurs that is not listed in the above table or if the problem cannot be solved with the proposed solutions, visit the Flex 5000 product page at www.sennheiser.com for the most up-to-date list of frequently asked questions.

You may also contact your local Sennheiser partner for assistance. To find a Sennheiser partner in your country, search at www.sennheiser.com.

Leaving the range of the transmitter

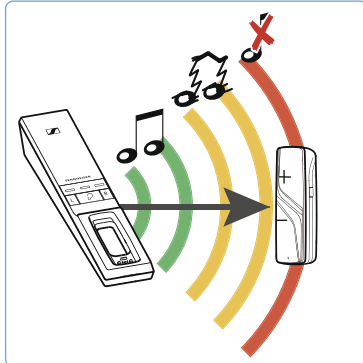

The range of the transmitter largely depends on environmental conditions such as wall thickness, wall composition etc. If the receiver leaves the range of the transmitter, the audio first cuts out occasionally until it finally cuts out completely. You hear alerts via the receiver and the *Receiver status* LED flashes green (or red if the rechargeable battery is almost empty).

If you re-enter the transmission range within 5 minutes, the connection is automatically re-established.

If you spend more than 5 minutes outside the transmission range, the receiver switches off automatically.

Specifications

Flex 5000 system

Carrier frequency	2.4 to 2.4835 GHz
Modulation	8-FSK Digital
Signal-to-noise ratio	analog input: typ. 85 dBA at 1 V _{rms} digital input: > 90 dBA
RF output power	max. 10 dBm
Audio latency	< 60 ms
Range	up to 30 m (line of sight)
Receivers that can be simultaneously connected to the transmitter	4
Temperature range	operation: 5 °C to +40 °C storage: -25 °C to +70 °C
Relative air humidity (non-condensing)	operation: 10 to 80 % storage: 10 to 90 %

RR Flex receiver

Connection	3.5 mm stereo jack socket for headphones (min. 16 Ω) or induction loop for hearing aids
Output voltage of jack socket	typ. 900 mV at 32 Ω
Operating time	up to 12 hours
Charging time of rechargeable battery	up to 3 hours
Power supply	built-in BAP 800 lithium polymer rechargeable battery, 3.7 V, 350 mAh
Weight	approx. 33 g
Dimensions (W x H x D)	approx. 29 mm x 87 mm x 25 mm

TR 5000 transmitter

Connections	digital input: optical supported data streams: PCM, 32 - 96 kHz/16 - 24 bit analog input: 3.5 mm jack socket input voltage range: 0.15 to 4.0 V _{pk}
Power supply	5 V $\overline{\text{---}}$, 1 A
Power consumption	operation: typ. 1 W standby: ≤ 0.5 W (without charging)
Dimensions (W x H x D)	approx. 50 mm x 42 mm x 270 mm

NT 5-10AW power supply unit

Nominal input voltage/ current	100 – 240 V~/ 300 mA
Power frequency	50 – 60 Hz
Nominal output voltage	5 V===
Nominal output current	1 A
Temperature range	operation: 0 °C to +40 °C storage: -25 °C to +70 °C
Relative air humidity (non-condensing)	operation: 10 to 80 % storage: 10 to 90 %

Hearing profiles 1-3

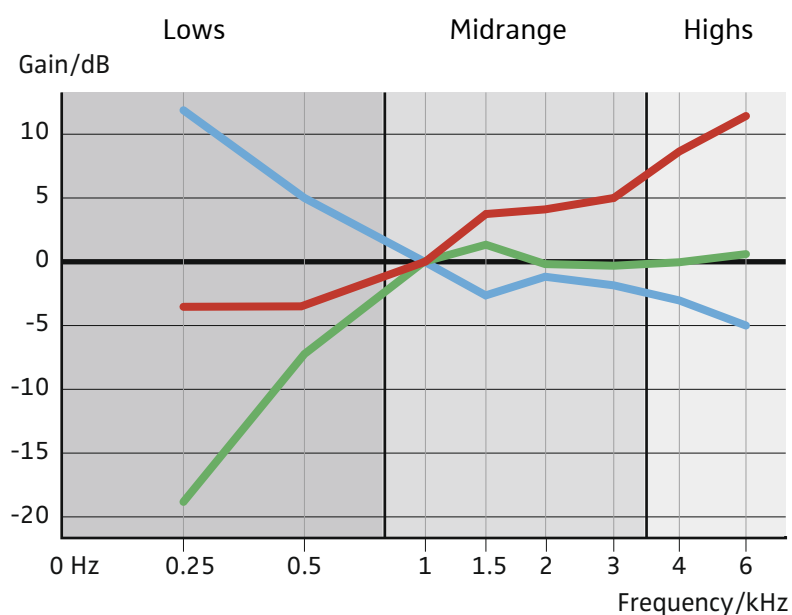

- Profile 1
- Profile 2
- Profile 3

Manufacturer Declarations

Warranty

Sennheiser electronic GmbH & Co. KG gives a warranty of 24 months on this product.

For the current warranty conditions, please visit our website at www.sennheiser.com or contact your Sennheiser partner.

FOR AUSTRALIA ONLY

Sennheiser goods come with guarantees that cannot be excluded under the Australian Consumer Law. You are entitled to a replacement or refund for a major failure and compensation for any other reasonably foreseeable loss or damage. You are also entitled to have the goods repaired or replaced if the goods fail to be of acceptable quality and the failure does not amount to a major failure.

This warranty is in addition to other rights or remedies under law. Nothing in this warranty excludes, limits or modifies any liability of Sennheiser which is imposed by law, or limits or modifies any remedy available to the consumer which is granted by law.

To make a claim under this warranty, contact Sennheiser Australia Pty Ltd, Unit 3, 31 Gibbes Street Chatswood NSW 2067, Australia; Phone: (02) 9910 6700, email: service@sennheiser.com.au

All expenses of claiming the warranty will be borne by the person making the claim.

The Sennheiser International Warranty is provided by Sennheiser Australia Pty Ltd (ABN 68 165 388 312), Unit 3, 31 Gibbes Street Chatswood NSW 2067, Australia.

In compliance with the following requirements

- WEEE Directive (2012/19/EU)



Please dispose of this product at the end of its operational lifetime by taking it to your local collection point or recycling center for such equipment. This will help to protect the environment in which we all live.

- Battery Directive (2006/66/EC & 2013/56/EU)



The supplied batteries/rechargeable batteries can be recycled. Please dispose of them as special waste or return them to your specialist dealer. In order to protect the environment, only dispose of exhausted batteries.

EU Declaration of Conformity



- ErP Directive (2009/125/EC)
- RoHS Directive (2011/65/EU)

Hereby, Sennheiser electronic GmbH & Co. KG declares that the radio equipment type TR 5000, RR Flex is in compliance with Directive 2014/53/EU.

The full text of the EU declaration of conformity is available at the following internet address:

www.sennheiser.com/download.

Statements regarding FCC and Industry Canada

FCC Declaration of Conformity (DoC)	
 SENNHEISER Model No: TR 2000, RR 2000, TR 5000, RR 5000, RR Flex	
We,	Sennheiser Electronic Corporation One Enterprise Drive • Old Lyme • CT 06371 • USA Tel: +1 (860) 434 9190 Fax: +1 (860) 434 1759
declare the above device comply with the requirements of Federal Communications Commission.	
This device complies with Part 15 of the FCC rules. Operation is subjected to the following two conditions:	
1) This device may not cause harmful interference, and 2) This device must accept any interference received, including interference that may cause undesired operation.	
Responsible Party: Markus Warlitz	

This device complies with Part 15 of the FCC rules and RSS-247 of Industry Canada. Operation is subject to the following two conditions: 1) This device may not cause harmful interference, and 2) This device must accept any interference received, including interference that may cause undesired operation.

This equipment has been tested and found to comply with the limits for a Class B digital device, pursuant to part 15 of the FCC rules and RSS-247 of Industry Canada. These limits are designed to provide reasonable protection against harmful interference in a residential installation. This equipment generates, uses and can radiate radio frequency energy and, if not installed and used in accordance with the instructions, may cause harmful interference to radio communications. However, there is no guarantee that interference will not occur in a particular installation. If this equipment does cause harmful interference to radio or television reception, which can be determined by turning the equipment off and on, the user is encouraged to try to correct the interference by one or more of the following measures:

- Reorient or relocate the receiving antenna.
- Increase the separation between the equipment and receiver.
- Connect the equipment into an outlet on a circuit different from that to which the receiver is connected.
- Consult the dealer or an experienced radio/TV technician for help.

Changes or modifications made to this equipment not expressly approved by Sennheiser electronic Corp. may void FCC authorization to operate this equipment.

CAN ICES-3 (B)/NMB-3(B)

Déclaration requise par la FCC et l'Industrie Canada

Cet appareil est conforme à la Partie 15 des réglementations de la FCC et à la norme CNR-210 d'Industrie Canada. L'utilisation de l'appareil doit respecter les deux conditions suivantes : (1) L'appareil ne doit pas produire d'interférences nuisibles, et, (2) il doit accepter toutes interférences reçues, y compris celles qui pourraient avoir des effets non désirés sur son fonctionnement.

CAN ICES-3 (B)/NMB-3(B)

RF Radiation Exposure Information

Since the radiated output power of this device is far below the FCC/IC radio frequency exposure limits, it is not subjected to routine RF exposure evaluation as per Section 2.1093 of the FCC rules and RSS-102 of Industry Canada.

This device meets FCC/IC RF exposure guidelines for an uncontrolled environment. The transmitter of this device should be installed and operated at least 20 cm away from the user's body. Use of other accessories not verified by the manufacturer may not ensure compliance with FCC/IC RF exposure guidelines.

This transmitter must not be co-located or operated in conjunction with any other antenna or transmitter.

Information sur l'exposition aux rayonnements radio fréquence (RF)

La puissance RF rayonnée de cet appareil étant de loin inférieure aux limites imposées par la FCC/IC, il n'est pas soumis à la réglementation sur l'exposition aux RF selon la section 2.1093 de la réglementation FCC et CNR-102 de Industrie Canada.

Cet équipement est conforme aux limites d'exposition aux rayonnements imposées par la FCC/IC pour un environnement non réglementé. L'émetteur de cet équipement doit être installé et utilisé à une distance minimale de 20 cm du corps de l'utilisateur. L'utilisation d'autres accessoires non homologués par le fabricant remet en cause la conformité des normes imposées par la FCC/IC.

Cet émetteur ne doit pas être positionné à proximité d'une autre antenne ou d'un autre émetteur, ni utilisé avec une autre antenne ou un autre émetteur.

Trademarks

Sennheiser is a registered trademark of Sennheiser electronic GmbH & Co. KG.

Other product and company names mentioned in this instruction manual may be the trademarks or registered trademarks of their respective holders.



Sennheiser electronic GmbH & Co. KG
Am Labor 1, 30900 Wedemark, Germany
www.sennheiser.com

Publ. 01/17, 570736/A01